

PST-324P

Option A
Pendant

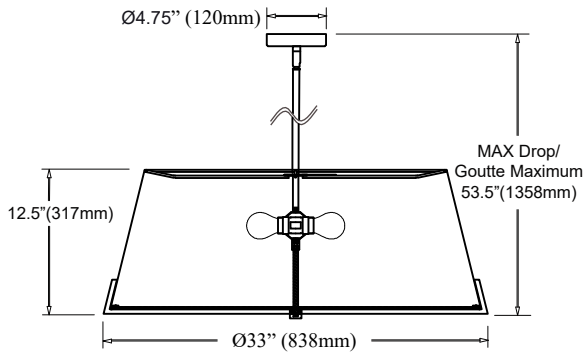

Option B
Semi-Flush

